

- Wichtige Hinweise:**
- Vor der Montage prüfen Sie bitte die Einstellung des Fensters bzw. der Fenstertür. Stellen Sie sicher, dass sich das Fenster/die Fenstertür einwandfrei öffnen und schließen lässt.
 - Messen Sie auch nach, ob die in Abb. 1b angegebenen Mindestmaße an Ihrem Fenster/Ihrer Fenstertür vorhanden sind.
 - Die Bohrlochtiefen bzw. die Schraubenlängen müssen auf die örtlichen Gegebenheiten abgestimmt werden.
 - Austreten des Bohrers bzw. der Schrauben auf der Rückseite vermeiden! Ggf. mit Bohranschlag arbeiten oder die vorhandenen Schrauben kürzen. Beim Bohren keine beweglichen Teile, Dichtungen oder Glasscheiben verletzen.

- Indications importantes:**
- Avant le montage contrôlez le réglage de la fenêtre ou de la porte-fenêtre. Assurez-vous que la fenêtre/porte-fenêtre ouvre et ferme parfaitement. Vérifiez si votre fenêtre/porte-fenêtre dispose des dimensions minimales indiquées en schéma 1b.
 - Les profondeurs de perçage ou les longueurs de vis doivent être adaptées aux conditions locales.
 - Évitez le dépassement de perçage ou de vis sur la face arrière! Utilisez le cas échéant une butée de perçage ou raccourcissez les vis de fixation.
 - Lors du perçage, évitez d'endommager les éléments mobiles, les joints ou les vitres.

- Belangrijke instructies:**
- Voor de montage dient u de afstelling van het raam resp. de deur te controleren. Stel evt. het beslag opnieuw in, zodat het correct functioneert.
 - Meet ook na, of de in afb. 1b aangegeven minimum afmetingen daadwerkelijk op uw raam/deur beschikbaar zijn.
 - De boordieptes en schroeflengtes moeten aan het gevelement aangepast worden.
 - Voorom doorboren en/of -schroeven. Evt. met booraanslag werken, kortere schroeven kopen of inkorten. Bij het boren geen bewegende delen, afdichtingen of glas beschadigen.

- Avvertenza importante:**
- Prima del montaggio verificare per favore la regolazione della finestra risp. della porta finestra. Se necessario registrare nuovamente i ferramenti affinché la finestra (la porta-finestra) si chiuda e si apra perfettamente.
 - Verificate anche che le misure minime indicate nell'ill. 1b esistono nelle vostre finestre/ porte-finestre.
 - Le profondità per trapanare i fori, risp. le lunghezze delle viti devono essere adattate alle condizioni particolari.
 - Evitare che la punta del trapano risp. la vite fuoriesca dall'altra parte! Se necessario lavorare con arresto del trapano o accorciare le viti. Quando si trapano, nondanneggiare parti mobili, guarnizioni o vetri.

- Important information:**
- Before installation, please check the setting of the window or French door. If necessary, readjust the fittings so that the window (French door) opens and closes perfectly.
 - Also check whether your window/French door complies with the minimum dimensions shown in fig. 1b.
 - The depths of the drilled holes and screw lengths must be adjusted to the local conditions. Avoid the drill or screws from coming out at the back!
 - Possibly work with drill stopper or shorten the existing screws. When drilling, do not damage any moving parts, seals or glass panes.



Allgemeine Hinweise
 Der Fenstergriff-Schloss F0400N ist nach den strengen Prüfanforderungen der DIN 18104-1 und VdS 2536 anerkannt. Durch DIN Certco ist F0400N zertifiziert „EINBRUCHHEMMD DIN-geprüft“. F0400N bietet zusätzlich Schutz gegen unberechtigtes Eindringen in ihre Räume. Gemäß DIN 18104-1 wird empfohlen, dass pro 1 Meter Fensterhöhe rechts und links jeweils eine Zusatzsicherung montiert wird (pro Fenster). Bei der Montage der F0400N sollte, der Fensterhöhe entsprechend, auf der Griffseite eventuell eine weitere Zusatzsicherung angebracht werden. Polizei und Versicherer empfehlen dieses ebenfalls. Die optimale Schutzwirkung erreichen Sie, wenn Sie entsprechend dieser Montage- und Bedienungsanleitung vorgehen. Die Befestigungsschrauben sollten zur Vermeidung von Überdrehung mit einem geeigneten Werkzeug eingeschraubt und von Hand angezogen werden. Ausschließlich ABUS-Befestigungsmaterial einsetzen.
 Für eventuell auftretende Verletzungen bzw. Schäden, die bei der Montage und/oder durch unsachgemäße Handhabung entstehen, übernimmt der Hersteller keine Haftung! Technische Änderungen vorbehalten. Für Irrtümer und Druckfehler keine Haftung.

Conseils d'ordre général
 La serrure de fenêtre F0400N satisfait aux exigences de contrôle sévères des normes DIN 18104-1 et VdS 2536. Le certificat DIN indique que F0400N a obtenu la qualification «anti-effraction DIN». F0400N offre en plus une protection contre les intrusions par effraction dans votre logement. Selon la norme DIN 18104-1, il est recommandé de monter une sécurité complémentaire par mètre de hauteur de fenêtre, à gauche comme à droite (par fenêtre).
 Lors de l'installation de F0400N, il est recommandé de monter éventuellement une sécurité complémentaire du côté de la poignée, en fonction de la hauteur de fenêtre. La police et les compagnies d'assurance le recommandent également. Pour un effet de protection optimal, suivez les instructions de ce manuel d'installation et d'utilisation. Afin d'éviter un serrage abusif, vissez et serrez les vis de fixation à la main et avec un outillage adéquat. Utilisez exclusivement des produits de fixation ABUS.
 Le fabricant n'assume aucune responsabilité pour d'éventuels blessures ou dégâts causés pendant l'installation et/ou par suite de manipulations inappropriées!
 Nous nous réservons le droit de toutes modifications techniques. Nous n'assumons aucune responsabilité par des erreurs ou défauts d'impression éventuels.

Algemeen
 Afsluitbare raamgreep voor naar binnen draaiende - en draaikep elementen. De F0400N biedt daarnaast bescherming tegen onbevoegd binnendringen van uw woning. Advies: monteer aan de sluitzijde voor maximale veiligheid 2 stuks per 1 meter raamhoogte. Op kunststof zonder metalen kern dient u dit slot in combinatie met ABUS BA bevestigingsanker te monteren. Optioneel verkrijgbaar, zie voor montage in de handleiding van BA.
 Optimale veiligheid wordt bereikt door nauwkeurig opvolgen van deze montage- en gebruiksaanwijzing. Om overexpansie of doldraaien van de bevestigingsschroeven te vermijden, draait u handmatig en met passend gereedschap de schroeven vast. Voor eventueel verwondingen en/of schade tijdens montage en/of door ondeskundig gebruik ontstaan, aanvaardt de fabrikant geen aansprakelijkheid!
 Technische wijzigingen voorbehouden. Geen aansprakelijkheid voor vergissingen en drukfouten.

Istruzioni generali
 La serratura per maniglie di finestra F0400N è conforme ai severi requisiti di controllo della DIN 18104-1 e della VdS 2536. Con la DIN Certco essa è certificata come «ANTISCASSO conf. DIN». La F0400N garantisce una protezione in più a difesa della Vostra casa. Secondo DIN 18104-1 si consiglia di montare per ogni metro di altezza della finestra, una sicura supplementare sul lato destro e una sul lato sinistro (per ogni finestra). Anche la polizia e le compagnie d'assicurazione consigliano tali misure.
 Si può ottenere una protezione ottimale, procedendo secondo queste istruzioni di montaggio ed uso. Le viti di fissaggio, per evitare un serraggio eccessivo, devono essere avvitate con un utensile adatto e poi serrate a mano. Impiegare esclusivamente materiale di fissaggio ABUS.
 Per eventuali ferimenti e/o danni, che si verificano durante il montaggio e/o per montaggio indebito, il produttore non si assume alcuna responsabilità!
 Ci si riservano modifiche tecniche. Per errori e refusi di stampa non ci si assume alcuna responsabilità.

General instructions
 The window handle lock F0400N is recognised as complying with the strict test requirements of DIN 18104-1 and VdS 2536. It is certified by DIN Certco as "BURGLAR RETARDANT DIN tested". F0400N offers additional protection from unauthorised intruders in your rooms. DIN 18104-1 recommends that an additional security device should be fitted on the left and right for every meter in height (per window). The police and insurance companies also give the same recommendation.
 Optimum protection can be achieved by proceeding according to these installation and operation instructions. To prevent the risk of overtightening, the fastening screws should be screwed in using a suitable tool and tightened by hand. Only use ABUS fastening material.
 The manufacturer does not assume any liability for possible injuries or damages caused during installation and/or by incorrect handling!
 Subject to technical alterations. No liability for mistakes and printing errors.

- ⚠ Achtung! Kleinteile können von Kindern verschluckt werden!
- ⚠ Attention! Les petites pièces peuvent être avalées par les enfants!
- ⚠ Let op! Kleine onderdelen kunnen door kinderen worden ingeslikt!
- ⚠ Attenzione! Piccole parti possono essere ingerite dai bambini!
- ⚠ Attention! Children can swallow small parts!
- ⚠ Vorsicht!
- ⚠ Attention!
- ⚠ Voorzichtig!
- ⚠ Attenzione!
- ⚠ Caution!
- ℹ Hinweise zur Montage
- ℹ Instructions de montage
- ℹ Instructies voor de montage
- ℹ Note per l'installazione
- ℹ Further fitting details

DE *ABUS August Bremicker Söhne KG Altenhofer Weg 25 D 58300 Wetter Tel.: +49 23 35 63 40 www.abus.com
 FR ABUS France SAS www.abus.fr

Ø 5,5 mm	Ø 4,0 mm	Ø 4,5 mm
Ø 4,8 mm	Ø 3,0 mm	Ø 3,5 mm
* 3 mm, Art.-Nr.: 31932		
* 4 mm, Art.-Nr.: 45915		
* 5,5 mm, Art.-Nr.: 31931		
	90%	10%

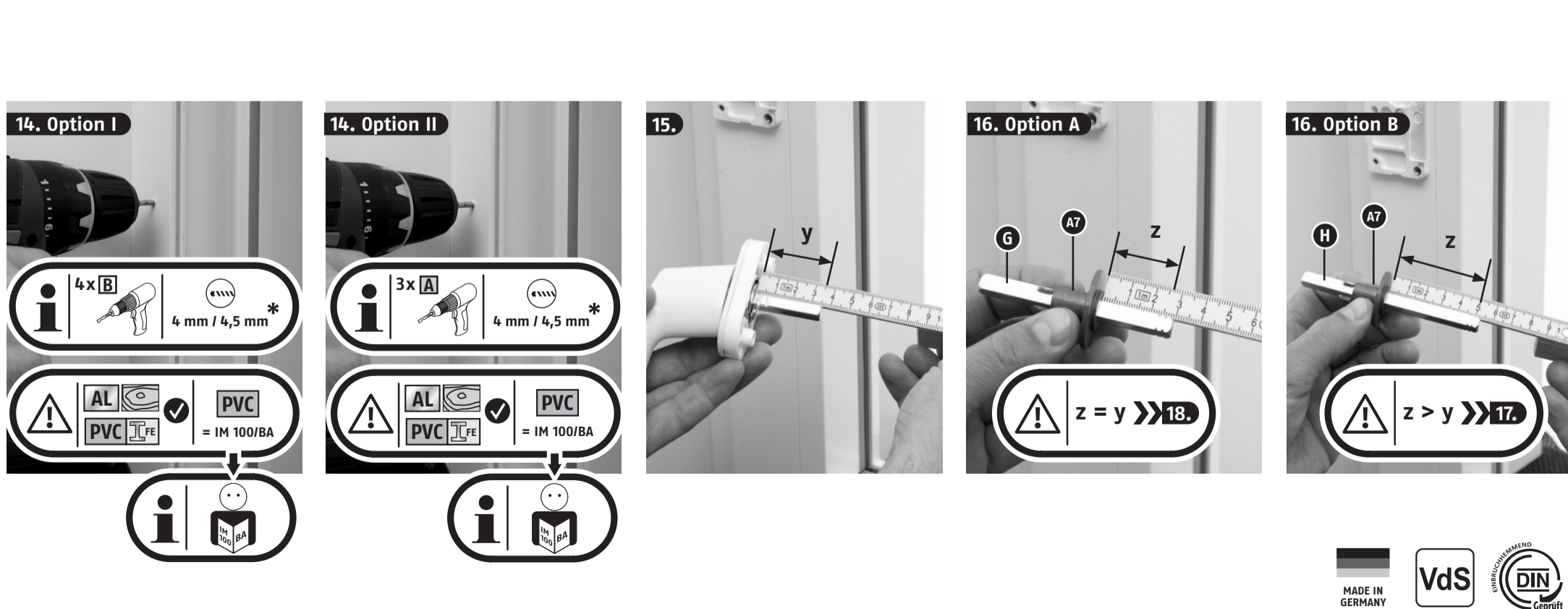
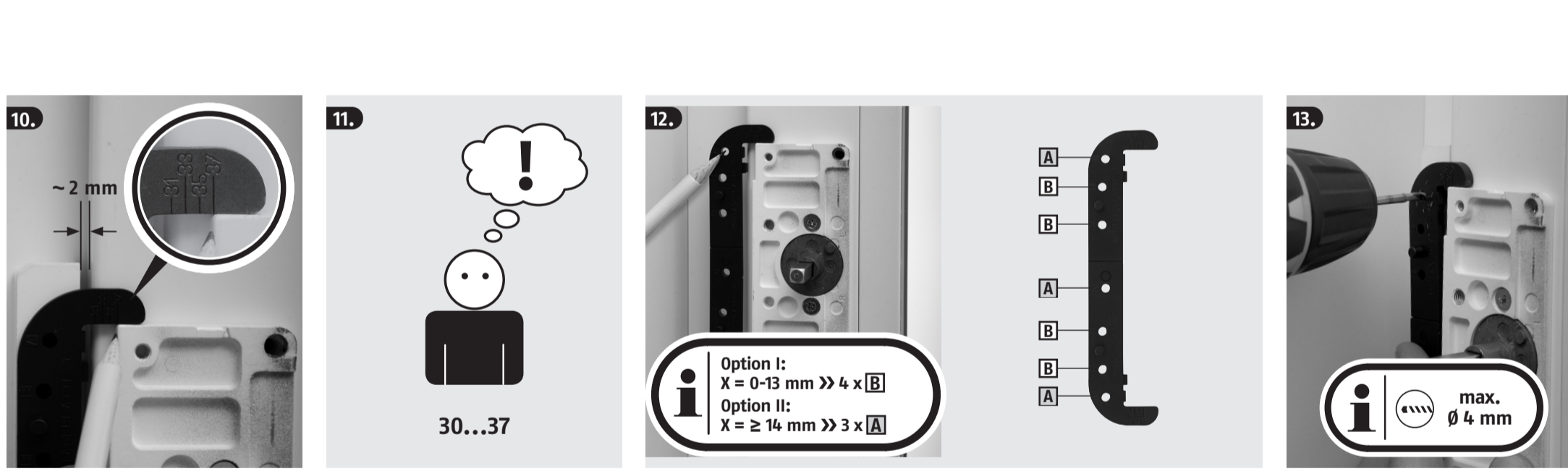
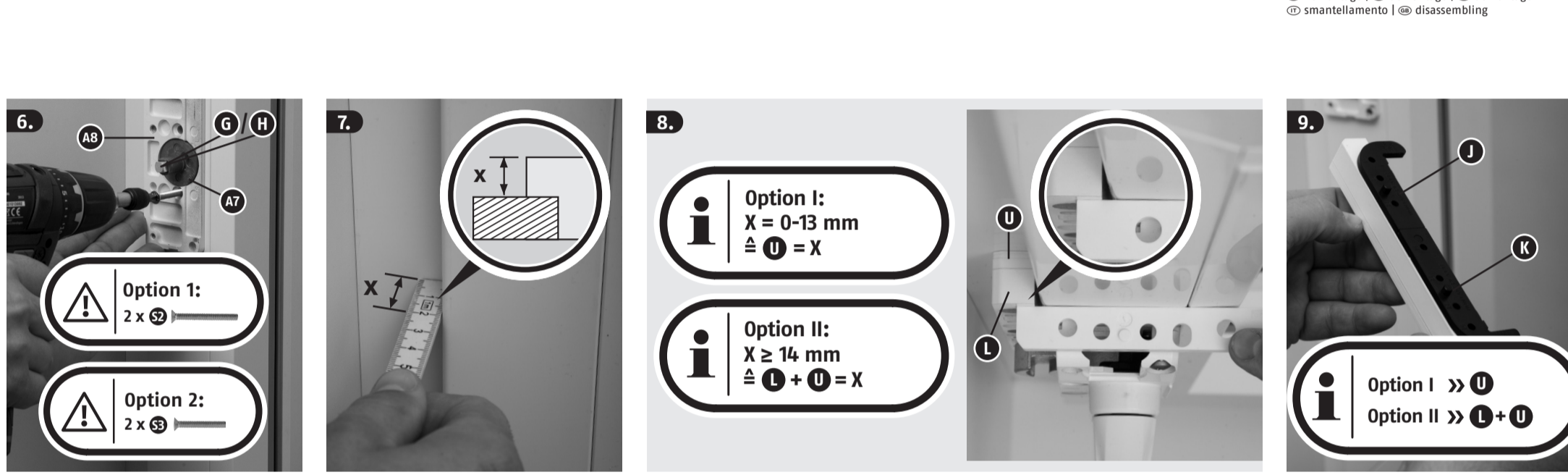
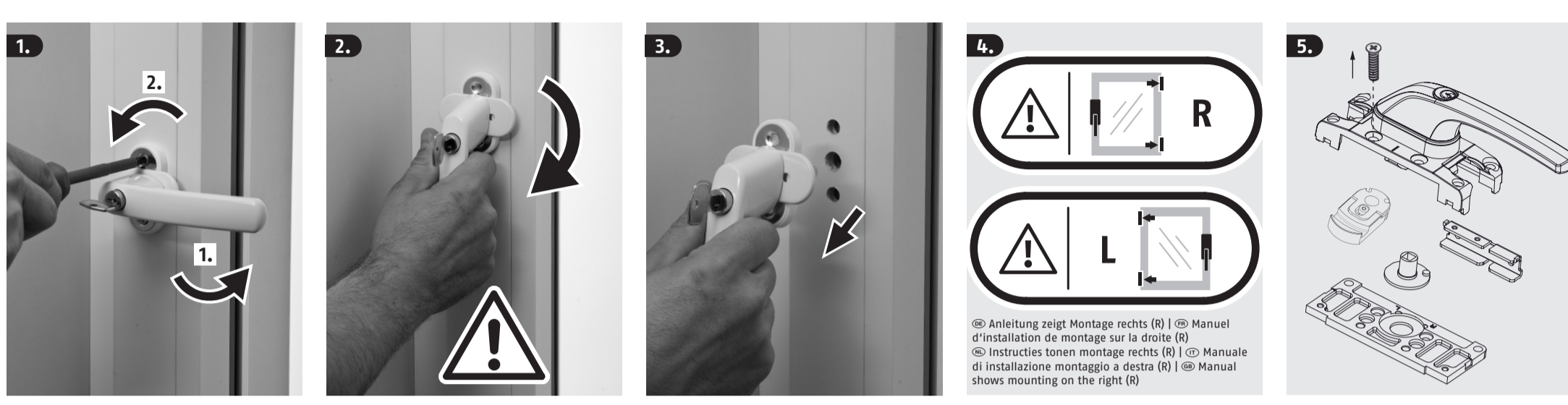

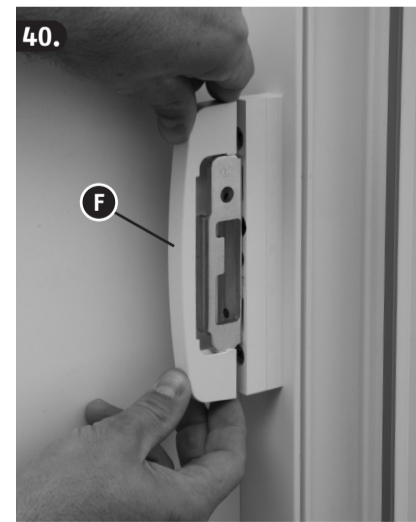
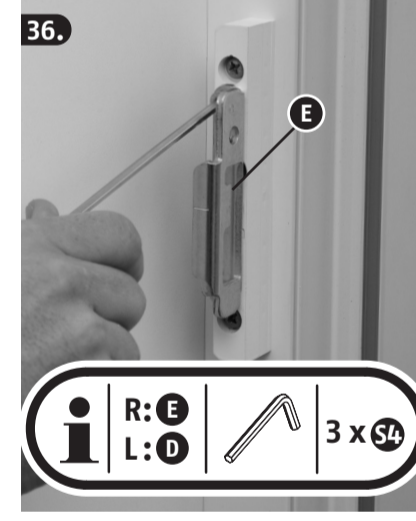
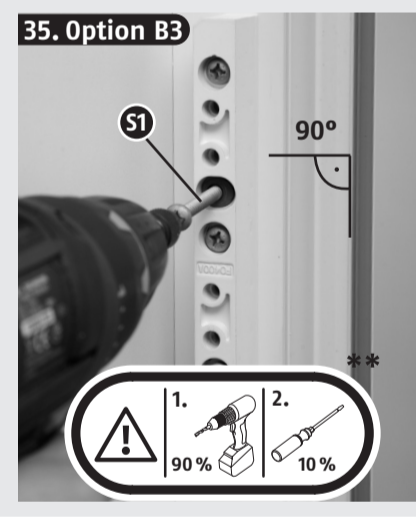
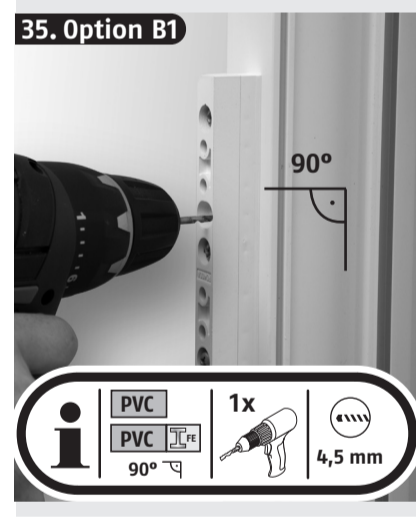
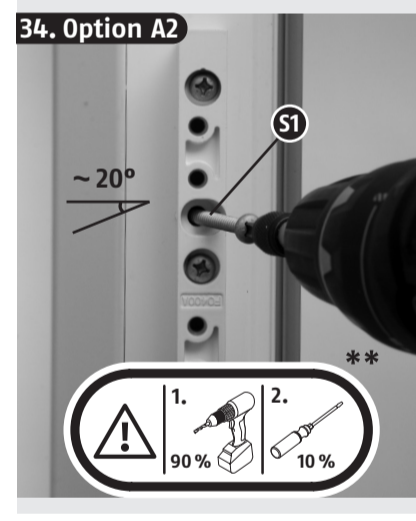
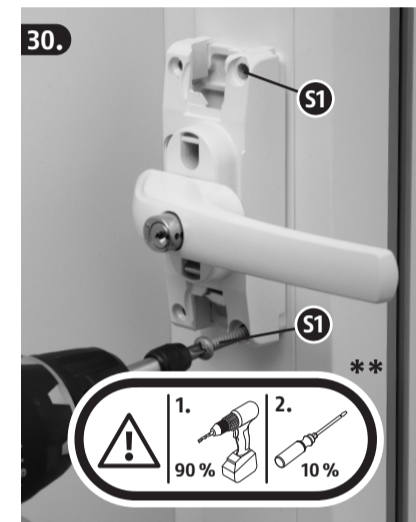
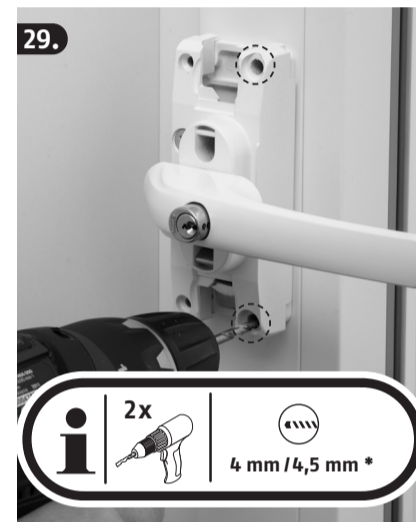
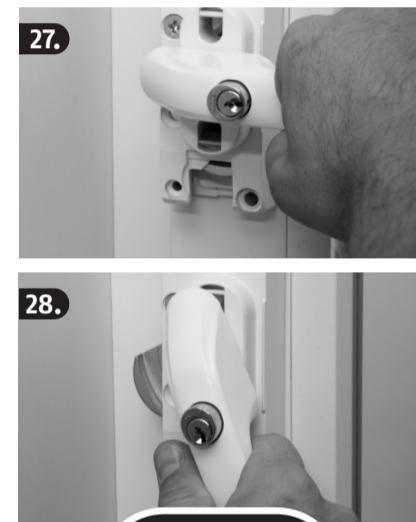
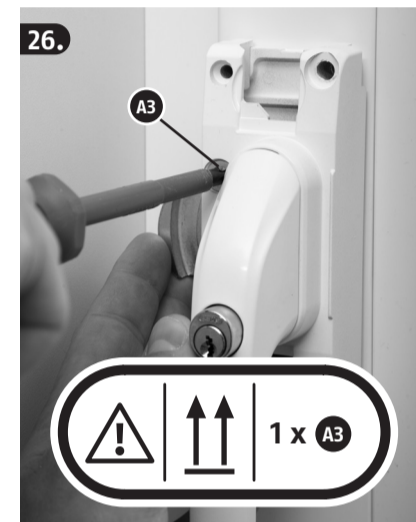
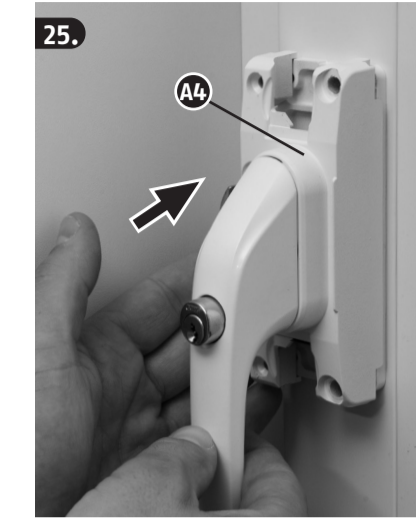
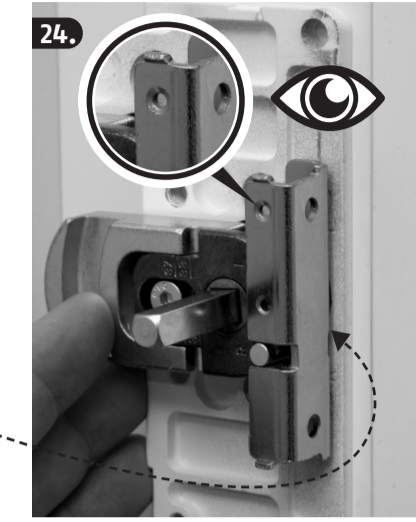
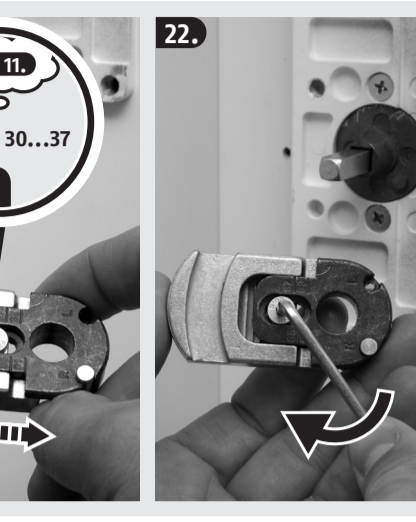
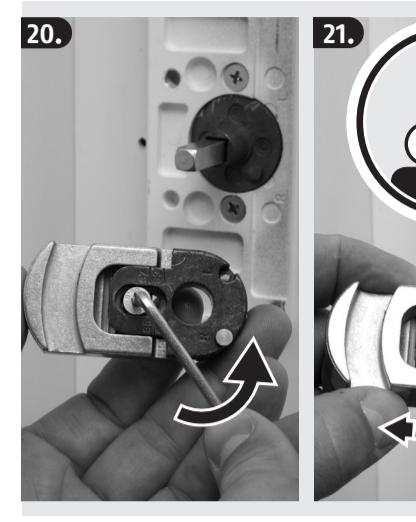
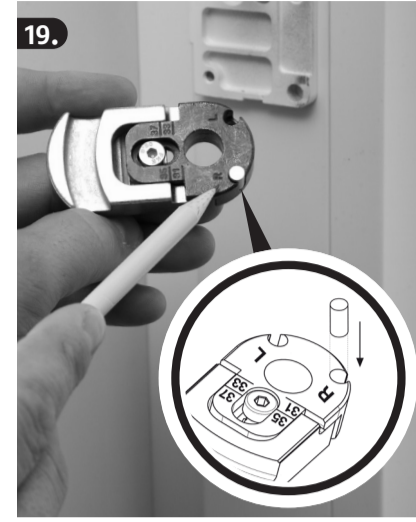
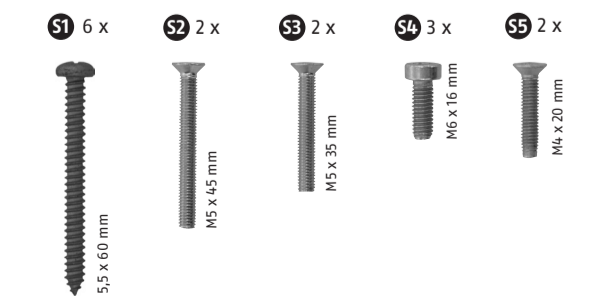
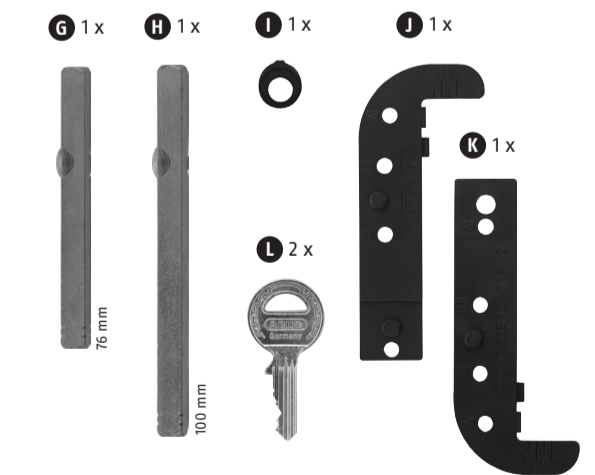
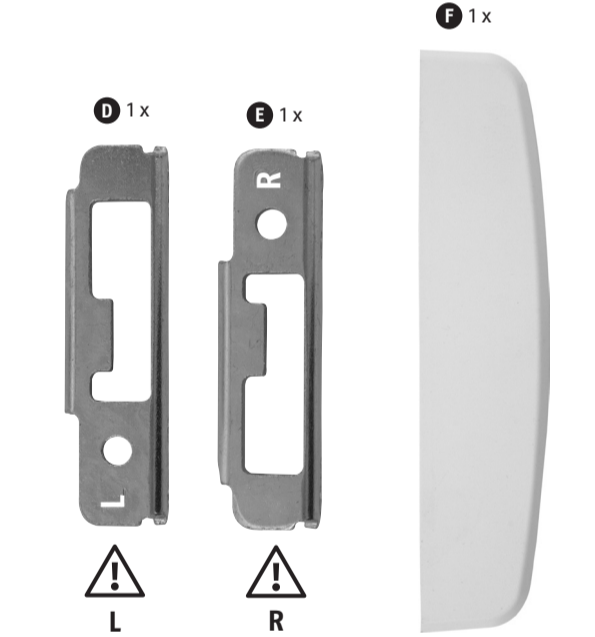
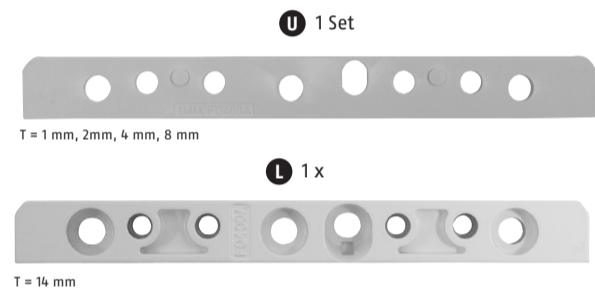
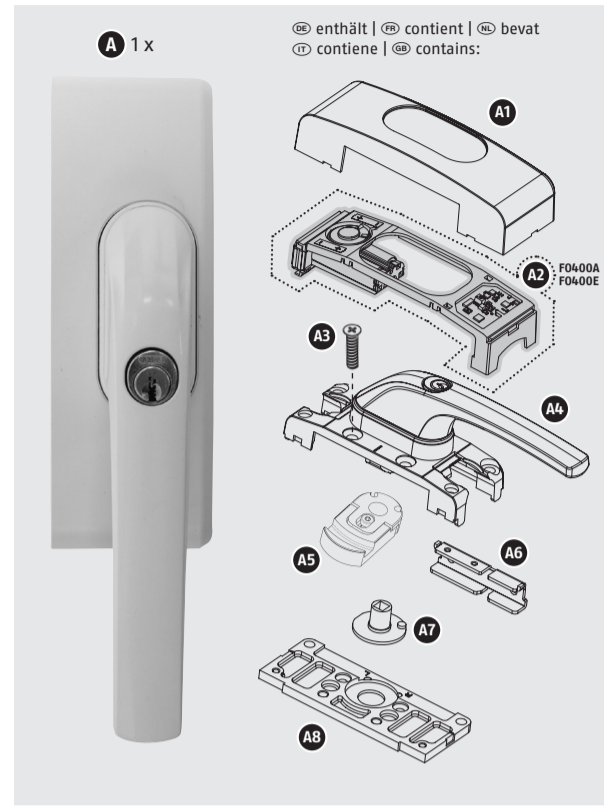

DE Bedienung
 FR Opération
 NL Operatie
 IT Funzionamento
 GB Operation

verriegelt | fermé | afgesloten | bloccato
 locked

entriegelt | pas verrouillé | niet vergrendeld
 non bloccato | not locked

geöffnet | ouvert | open | aperto | open

gekippt | inclinasion | kantelen | tilt | tilt

geneigt mit blockiertem Griff | incliner avec poignée bloqué | kantelen met geblokkede handvat
 tilt con maniglia bloccata | tilt with blocked handle